

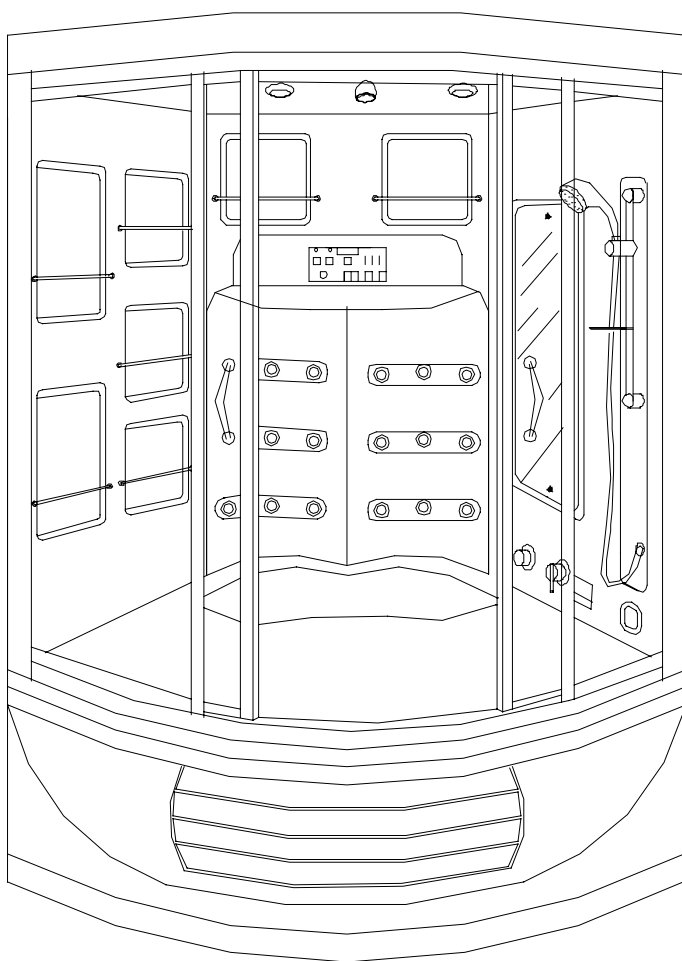

ZAA216 INSTALL INSTRUCTION

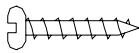
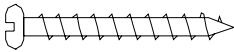
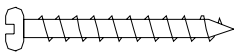
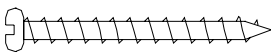
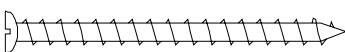

ZAA216 INSTALL INSTRUCTION

| | | | |
|-------|---|----|---|
| M4x12 |  | 15 | A |
| | | | B |
| M4x20 |  | 8 | C |
| M5x25 |  | 6 | D |
| M4x30 |  | 8 | E |
| M4x60 |  | 4 | F |
| M5x22 |  | 22 | G |
| M5x35 |  | 6 | H |
| | | | |
| | | | |

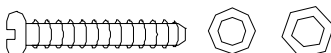
ZAA216 INSTALL INSTRUCTION

J

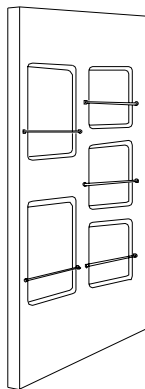
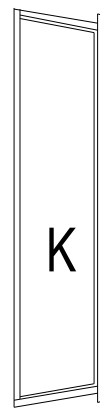
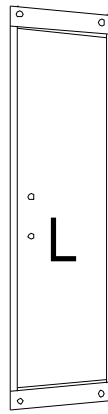
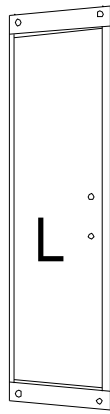
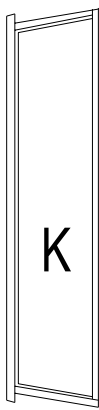
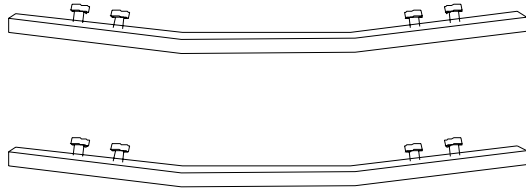

M

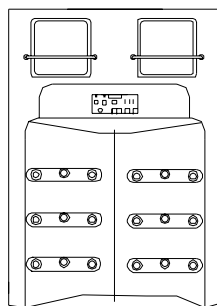

N

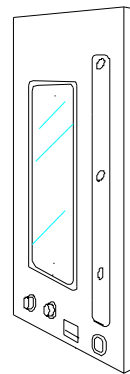

O

ZAA216 INSTALL INSTRUCTION

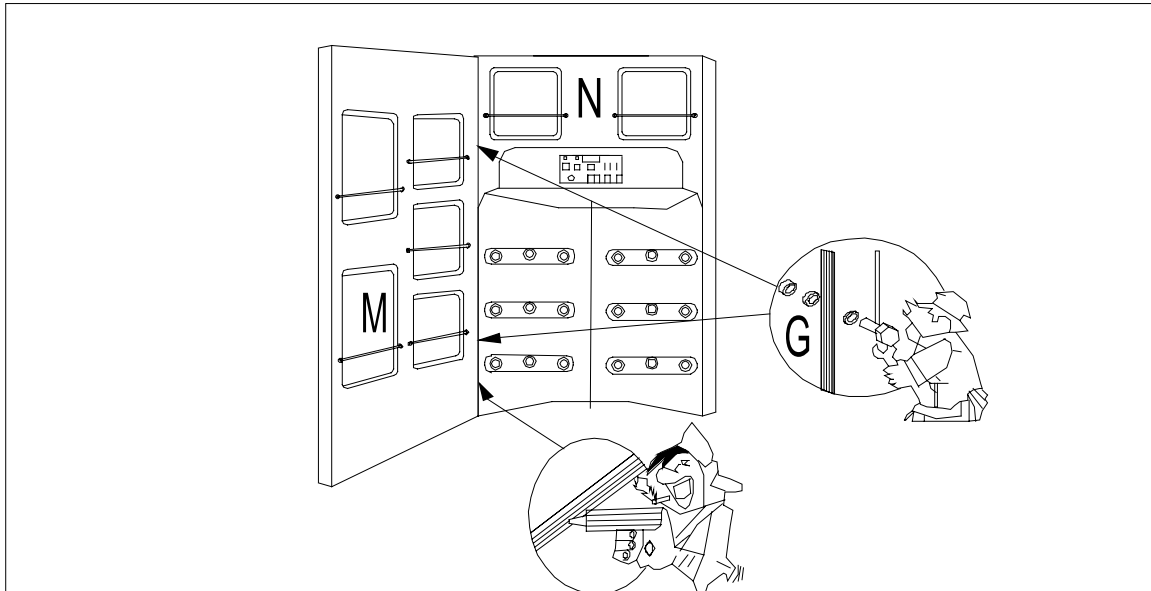

1. place M beside N, right into the groove, connect with G, then seal the connections with sealant.

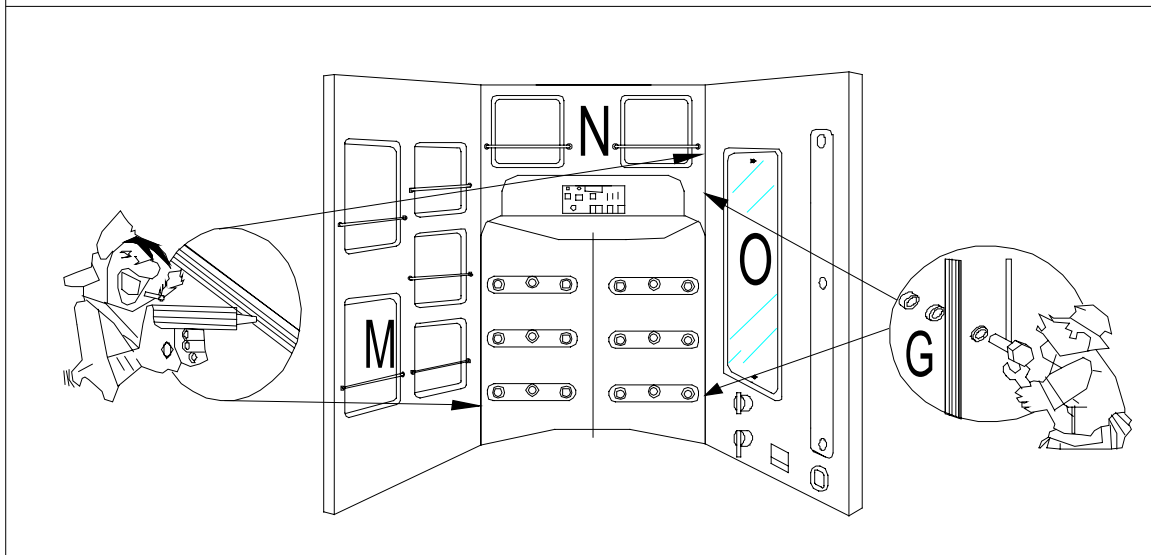

2. place O close N another side, right into the groove, connect with G, then seal the connections with sealant.

ZAA216 INSTALL INSTRUCTION

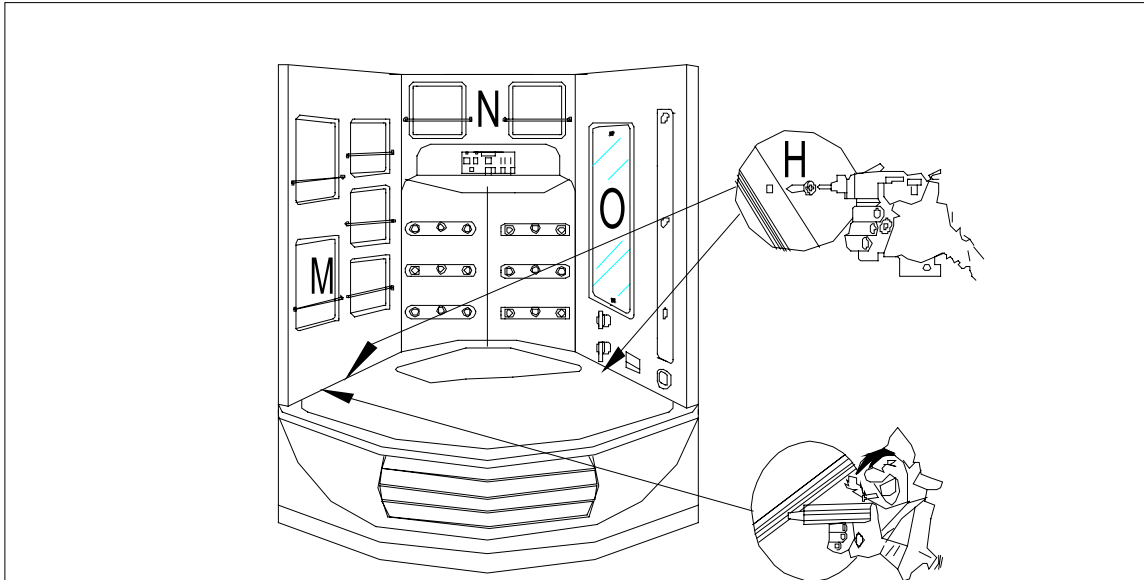

3. Place the installed back board above the message tube, right to the groove, fix with H, seal the connections with sealant.

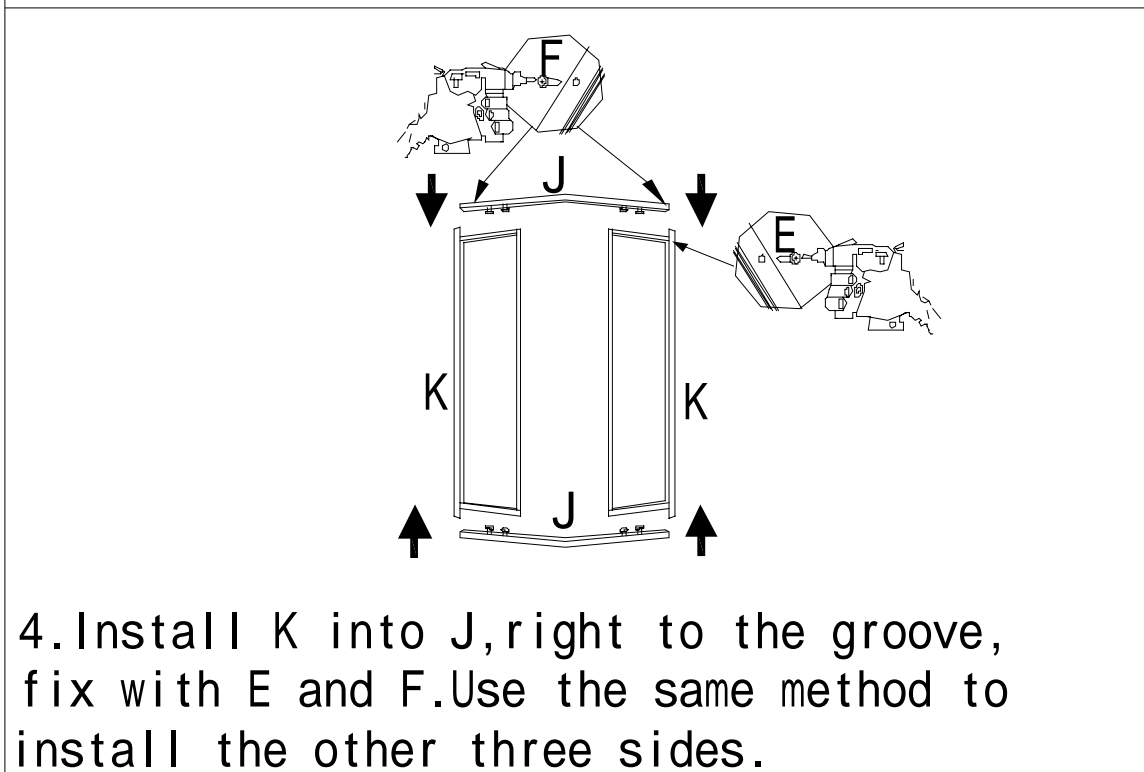

4. Install K into J, right to the groove, fix with E and F. Use the same method to install the other three sides.

ZAA216 INSTALL INSTRUCTION

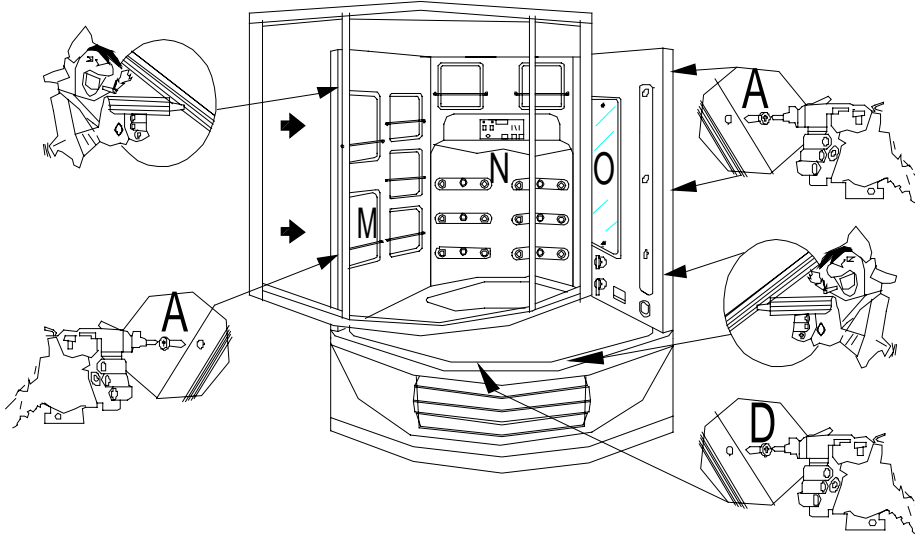

5. Place the installed glass frame above the message tub, close the back board tightly, right to the groove, fix with A and D, seal the connection with sealant.

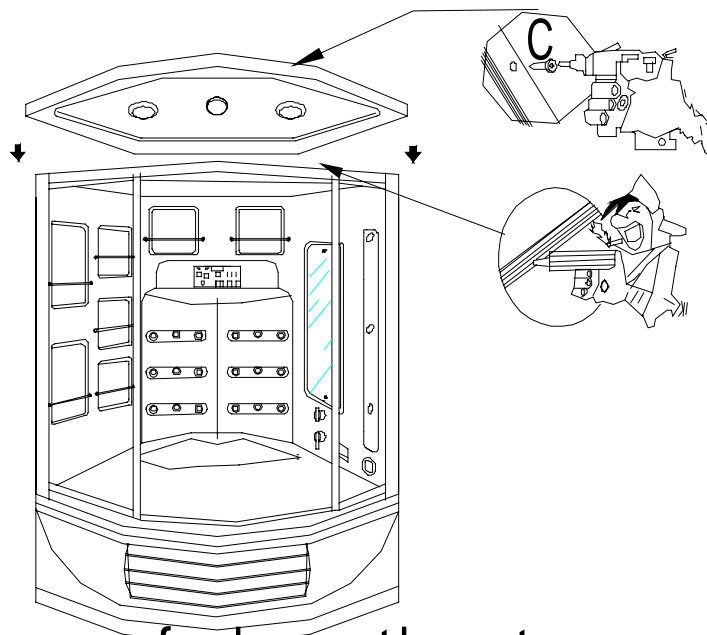

6. Place the roof above the steam cabinet, right to the groove, fix with C, seal the connection with sealant.

ZAA216 INSTALL INSTRUCTION

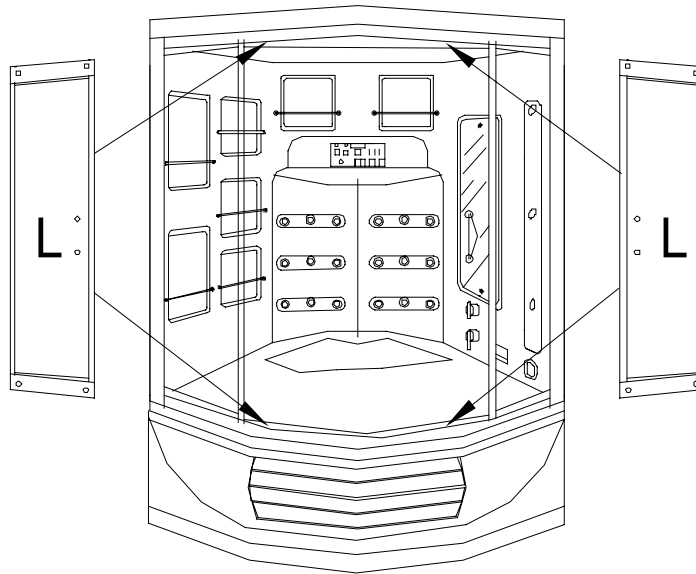

7. Install L into the pulley of the track, adjust the pulleys, make them work smoothly and fluctuate plumbly. Then use the same method to install another one.

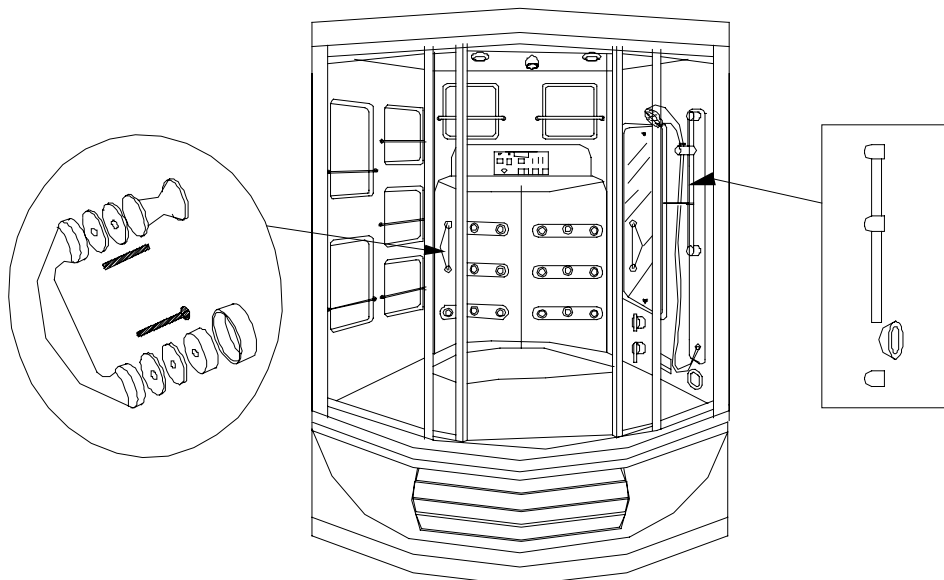

8. Install the shower and handles. connect the feeding line and joint water supply and drainage system.